

TB 9-6625-2155-35

CHANGE 5

DEPARTMENT OF THE ARMY TECHNICAL BULLETIN

CALIBRATION PROCEDURE FOR SIGNAL GENERATOR SG-1219/U (HEWLETT-PACKARD, MODEL 8673M)

Headquarters, Department of the Army, Washington, DC

27 October 2005

Distribution Statement A: Approved for public release; distribution is unlimited.

TB 9-6625-2155-35, 27 August 2003, is changed as follows:

1. Remove old pages and insert new pages as indicated below. New or changed material is indicated by a vertical bar in the margin of the page.

Remove Pages

3 and 4
15 and 16

Insert Pages

3 and 4
15 and 16

2. File this change sheet in front of the publication for reference purposes.

By Order of the Secretary of the Army:

Official



SANDRA R. RILEY
*Administrative Assistant to the
Secretary of the Army*

0524203

PETER J. SCHOOMAKER
*General, United States Army
Chief of Staff*

Distribution:

To be distributed in accordance with IDN 342253 requirements for calibration procedure TB 9-6625-2155-35.

TB 9-6625-2155-35

CHANGE 4

DEPARTMENT OF THE ARMY TECHNICAL BULLETIN

CALIBRATION PROCEDURE FOR SIGNAL GENERATOR SG-1219/U (HEWLETT-PACKARD, MODEL 8673M)

Headquarters, Department of the Army, Washington, DC
15 September 2005

Distribution Statement A: Approved for public release; distribution is unlimited.

TB 9-6625-2155-35, 27 August 2003, is changed as follows:

1. Remove old pages and insert new pages as indicated below. New or changed material is indicated by a vertical bar in the margin of the page.

Remove Pages
19 and 20

Insert Pages
19 and 20

2. File this change sheet in front of the publication for reference purposes.

By Order of the Secretary of the Army:

Official



SANDRA R. RILEY
*Administrative Assistant to the
Secretary of the Army*

0520008

PETER J. SCHOOMAKER
*General, United States Army
Chief of Staff*

Distribution:

To be distributed in accordance with IDN 342253 requirements for calibration procedure
TB 9-6625-2155-35.

TB 9-6625-2155-35

CHANGE 3

DEPARTMENT OF THE ARMY TECHNICAL BULLETIN

CALIBRATION PROCEDURE FOR SIGNAL GENERATOR SG-1219/U (HEWLETT-PACKARD, MODEL 8673M)

Headquarters, Department of the Army, Washington, DC

13 July 2005

Distribution Statement A: Approved for public release; distribution is unlimited.

TB 9-6625-2155-35, 27 August 2003, is changed as follows:

1. Remove old pages and insert new pages as indicated below. New or changed material is indicated by a vertical bar in the margin of the page.

Remove Pages

5 and 6
13 and 14
21 and 22
25 and 26

Insert Pages

5 and 6
13 and 14
21 and 22
25 and 26

2. File this change sheet in front of the publication for reference purposes.

By Order of the Secretary of the Army:

Official



SANDRA R. RILEY

*Administrative Assistant to the
Secretary of the Army*

0514404

PETER J. SCHOOMAKER
*General, United States Army
Chief of Staff*

Distribution:

To be distributed in accordance with IDN 342253 requirements for calibration procedure
TB 9-6625-2155-35.

TB 9-6625-2155-35

CHANGE 2

DEPARTMENT OF THE ARMY TECHNICAL BULLETIN

CALIBRATION PROCEDURE FOR SIGNAL GENERATOR SG-1219/U (HEWLETT-PACKARD, MODEL 8673M)

Headquarters, Department of the Army, Washington, DC
26 January 2005

Distribution Statement A: Approved for public release; distribution is unlimited.

TB 9-6625-2155-35, 27 August 2003, is changed as follows:

1. Remove old pages and insert new pages as indicated below. New or changed material is indicated by a vertical bar in the margin of the page.

Remove Pages
5 thru 14

Insert Pages
5 thru 14

2. File this change sheet in front of the publication for reference purposes.

By Order of the Secretary of the Army:

Official



SANDRA R. RILEY
*Administrative Assistant to the
Secretary of the Army*

0433401

PETER J. SCHOOMAKER
*General, United States Army
Chief of Staff*

Distribution:

To be distributed in accordance with IDN 342253 requirements for calibration procedure
TB 9-6625-2155-35.

TB 9-6625-2155-35

CHANGE 1

DEPARTMENT OF THE ARMY TECHNICAL BULLETIN

CALIBRATION PROCEDURE FOR SIGNAL GENERATOR SG-1219/U (HEWLETT-PACKARD, MODEL 8673M)

Headquarters, Department of the Army, Washington, DC
16 December 2004

Distribution Statement A: Approved for public release; distribution is unlimited.

TB 9-6625-2155-35, 27 August 2003, is changed as follows:

1. Remove old pages and insert new pages as indicated below. New or changed material is indicated by a vertical bar in the margin of the page.

Remove Pages

3 thru 14
17 thru 30

Insert Pages

3 thru 14
17 thru 30

2. File this change sheet in front of the publication for reference purposes.

By Order of the Secretary of the Army:

Official:



SANDRA R. RILEY

*Administrative Assistant to the
Secretary of the Army*

0429204

PETER J. SCHOOMAKER
*General, United States Army
Chief of Staff*

Distribution:

To be distributed in accordance with IDN 342253 requirements for calibration procedure
TB 9-6625-2155-35.

*TB 9-6625-2155-35

DEPARTMENT OF THE ARMY TECHNICAL BULLETIN

CALIBRATION PROCEDURE FOR SIGNAL GENERATOR SG-1219/U (HEWLETT-PACKARD, MODEL 8673M)

Headquarters, Department of the Army, Washington, DC
27 August 2003

Approved for public release; distribution is unlimited.

REPORTING OF ERRORS AND RECOMMENDING IMPROVEMENTS

You can improve this manual. If you find any mistakes or if you know of a way to improve these procedures, please let us know. Mail your letter or DA Form 2028 (Recommended Changes to Publications and Blank Forms) directly to: Commander, U.S. Army Aviation and Missile Command, ATTN: AMSAM-MMC-MA-NP, Redstone Arsenal, AL 35898-5000. A reply will be furnished to you. You may also provide DA Form 2028 information to AMCOM via e-mail, fax, or the World Wide Web. Our fax number is DSN 788-6546 or Commercial 256-842-6546. Our e-mail address is: 2028@redstone.army.mil. Instructions for sending an electronic 2028 may be found at the back of this manual. For the World Wide Web, use <https://amcom2028.redstone.army.mil>.

SECTION		Paragraph	Page
	I. IDENTIFICATION AND DESCRIPTION		
	Test instrument identification	1	2
	Forms, records, and reports	2	2
	Calibration description	3	2
	II. EQUIPMENT REQUIREMENTS		
	Equipment required	4	3
	Accessories required	5	3
	III. CALIBRATION PROCESS		
	Preliminary instructions	6	4
	Equipment Setup	7	5
	Display resolution and accuracy	8	6
	Single sideband phase noise	9	9
	Harmonics, subharmonics, multiples and nonharmonic spurious signals	10	10
	RF output level	11	12
	Pulse modulation	12	18
	Amplitude modulation	13	22
	Frequency modulation	14	26
	Power supply	15	30
	Final procedure	16	32

*This bulletin supersedes TB 9-6625-2155-35, dated 6 December 2000.

**SECTION I
IDENTIFICATION AND DESCRIPTION**

1. Test Instrument Identification. This bulletin provides instructions for the calibration of Signal Generator, SG-1219/U (Hewlett-Packard, Model 8673M). The manufacturer’s manual and TM 11-6625-3143-40 were used as the prime data sources in compiling these instructions. The equipment being calibrated will be referred to as the TI (test instrument) throughout this bulletin.

a. Model Variations. None.

b. Time and Technique. The time required for this calibration is approximately 8 hours, using the dc and low frequency and microwave techniques.

2. Forms, Records, and Reports

a. Forms, records, and reports required for calibration personnel at all levels are prescribed by TB 750-25.

b. Adjustments to be reported are designated (R) at the end of the sentence in which they appear. When adjustments are in tables, the (R) follows the designated adjustment. Report only those adjustments made and designated with (R).

3. Calibration Description. TI parameters and performance specifications which pertain to this calibration are listed in table 1.

Table 1. Calibration Description

Test instrument parameters	Performance specifications
Display accuracy and resolution 2 to 18 GHz	Display: ± 500 kHz Resolution: 3 kHz
Single sideband phase noise	<-60 dBc 1 kHz offset from carrier
Harmonics: Subharmonics Spurious signals	<-40 dBc <-35 dBc <-50 dBc
Reference oscillator	Accuracy: 1×10^{-8} per 10 s^1
RF output level	Range: +8 dBm to -120 dBm ²
Level accuracy: 2.0 to 12.0 GHz	±2.0 dB (+8 to -60 dBm output level) ±3.5 dB (-61 to -120 dBm output level)
>12.0 to 18.0 GHz	±3.0 dB (+8 to -60 dBm output level) ±4.5 dB (-61 to -120 dBm output level)
Pulse modulation: RF pulse width Maximum peak power Overshoot Undershoot	≥80 ns +3 dBm <20% of carrier level <20% of carrier level

See footnotes at end of table.

Table 1. Calibration Description - Continued

Test instrument parameters	Performance specifications
Amplitude modulation: Meter accuracy Depth Rates Incidental FM	± 7% of reading ± 3% of range 0 to 75%: 2.0 to 18.0 GHz 0 dBm maximum carrier level 10 Hz to 50 kHz: 3 dB bandwidth 30% depth <10 kHz p-p ³ : 30% modulation depth
Frequency modulation: Meter accuracy Frequency response relative to a 100 kHz rate Maximum deviation Distortion Incidental AM	±7% of reading ±3% of range ±3 dB, 50 Hz to 2 MHz 10 MHz 50 kHz to 1 MHz modulation rate 10 MHz/V deviation range <5% 100 kHz rate at 1 MHz peak deviation <5% Rates <100 kHz; peak deviations ≤1 MHz

¹As per CECOM specification.

²Calibrated to -100 dBm ≤12.4 GHz, -90 dBm 12.4 GHz to 18 GHz.

³Procedure limitation (see text).

SECTION II EQUIPMENT REQUIREMENTS

4. Equipment Required. Table 2 identifies the specific equipment to be used in this calibration procedure. This equipment is issued with Secondary Transfer calibration Standards Set AN/GSM-287 or AN/GSM-705. Alternate items may be used by the calibrating activity. The items selected must be verified to perform satisfactorily prior to use and must bear evidence of current calibration. The equipment must meet or exceed the minimum use specifications listed in table 2. The accuracies listed in table 2 provide a four-to-one ratio between the standard and TI.

5. Accessories Required. The accessories required for this calibration are common usage accessories, issued as indicated in paragraph 4 above, and are not listed in this calibration procedure. The following peculiar accessory is also required for this calibration: Mixer, RHG Model DM 1-18A (P/N 21-159-2).

Table 2. Minimum Specifications of Equipment Required

Common name	Minimum use specifications	Manufacturer and model (part number)
ATTENUATOR SET (FIXED)	Range: 2 to 18 GHz Accuracy: (See test report)	Weinschel, Model 9918 (9918)
AUDIO ANALYZER	Range: 1.0 to 100.0 kHz Accuracy: <2.0%	Boonton, Model 1121 (1121)
FREQUENCY DIFFERENCE METER	Range: 10 MHz Resolution: 1 part in 10 ⁻⁸	Tracor, Model 527E

Table 2. Minimum Specifications of Equipment Required - Continued

Common name	Minimum use specifications	Manufacturer and model (part number)
MEASURING RECEIVER	Range: 2.0 to 18 GHz Range: +8 to -74.5 dBm Accuracy: +.5 dB Range: AM 0 to 80% Accuracy: ±2% at 1 kHz Range: FM .05 to 100 kHz Accuracy: ±2% at 1 kHz Deviation: ±12 kHz	Hewlett-Packard, Model 8902A w/sensor, Hewlett Packard, Model 11792A (11792A), and microwave converter, model 11793A (11793A)
MULTIMETER	Range: 0 to 40 V dc Accuracy: 0.01%	John Fluke, Model 8840A/AF 05/09 (AN/GSM-64D)
OSCILLOSCOPE	Range: 5.0 V at 100 ns Accuracy: 3.0%	(OS-303/G)
PULSE GENERATOR	Range: Period 10 µs Accuracy: Determined by oscilloscope	Lecroy Model 9210 (9210) with plug-in, Model 9211 (9211)
SYNTHESIZED SIGNAL GENERATOR	Range: Output level +8 dBm Frequency range: 2 to 18 GHz	Anritsu, Model 68369NV (68369NV)
SPECTRUM ANALYZER	Range: 2.0 to 18 GHz at +10 to -60 to dBm Accuracy: ±0.2% of the center frequency +20% of the span/div Range: Span 500 Hz to 20 MHz Accuracy: ±5%	(AN/USM-677)
TIME/FREQUENCY WORKSTATION	Frequency: 1 MHz Accuracy: 5 parts in 10 ⁻¹⁰ per day	Datum, Model ET6000-75 (13589305)

SECTION III CALIBRATION PROCESS

6. Preliminary Instructions

a. The instructions outlined in paragraphs 6 and 7 are preparatory to the calibration process. Personnel should become familiar with the entire bulletin before beginning the calibration.

b. Items of equipment used in this procedure are referenced within the text by common name and item identification number as listed in table 2.

c. Unless otherwise specified, verify the result of each test and, whenever the test requirement is not met, take corrective action before continuing with the calibration. Additional maintenance information is contained in the manufacturer's manual and TM 11-6625-3143-40 for this TI.

d. When indications specified in paragraphs 8 through 14 are not within tolerance, perform the power supply check prior to making adjustments. After adjustments are made, repeat paragraphs 8 through 14. Do not perform power supply check if all other parameters are within tolerance.

e. Unless otherwise specified, all controls and control settings refer to the TI.

7. Equipment Setup

WARNING

HIGH VOLTAGE is used or exposed during the performance of this calibration. DEATH ON CONTACT may result if personnel fail to observe safety precautions. REDUCE OUTPUT(S) to minimum after each step within the performance check where applicable.

- a. Remove TI from protective cover only as necessary to make adjustments. Replace cover after completing the adjustments

NOTE

For the remainder of this procedure the 68369NV connected to the measuring receiver will be called the local oscillator.

NOTE

Many indications, such as MESSAGE, ΔF , SWEEP FREQ START, etc., will only appear when the appropriate entry pushbutton is pressed and held in the IN position.

- b. Connect TI to a 115 V ac power source.
- c. Set LINE switch to ON and allow a 2 hour warm-up and stabilization.
- d. Connect FREQUENCY STD INT connector of TI to SIG INPUT of frequency difference meter. Set FREQUENCY STANDARD INT/EXT SWITCH to INT.
- e. Connect 1 MHz output of GPS time/frequency workstation to REF INPUT of the frequency difference meter.
- f. Adjust FREQ adjust A3A8 (fig. 1) for minimum frequency difference meter indication.
- g. Verify oscillator drift is less than 1 part in 10^{-8} per 10 s.

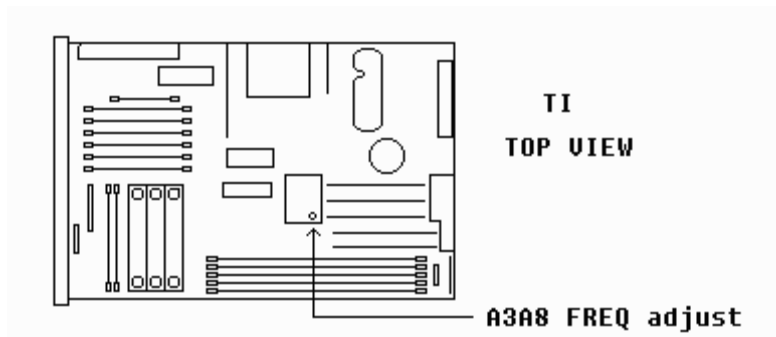

Figure 1. Frequency adjust location.

h. Replace TI top cover.

i. Disconnect frequency difference meter from the TI and the GPS time/frequency workstation.

8. Display Resolution and Accuracy

a. Performance Check

(1) Connect the local oscillator **10 MHz REF OUT** to the measuring receiver **TIME BASE 10 MHz INPUT**.

(2) Connect TI **10 MHz OUT** (rear panel) to the local oscillator **10 MHz REF IN** connector.

(3) Finish connection as shown in figure 2.

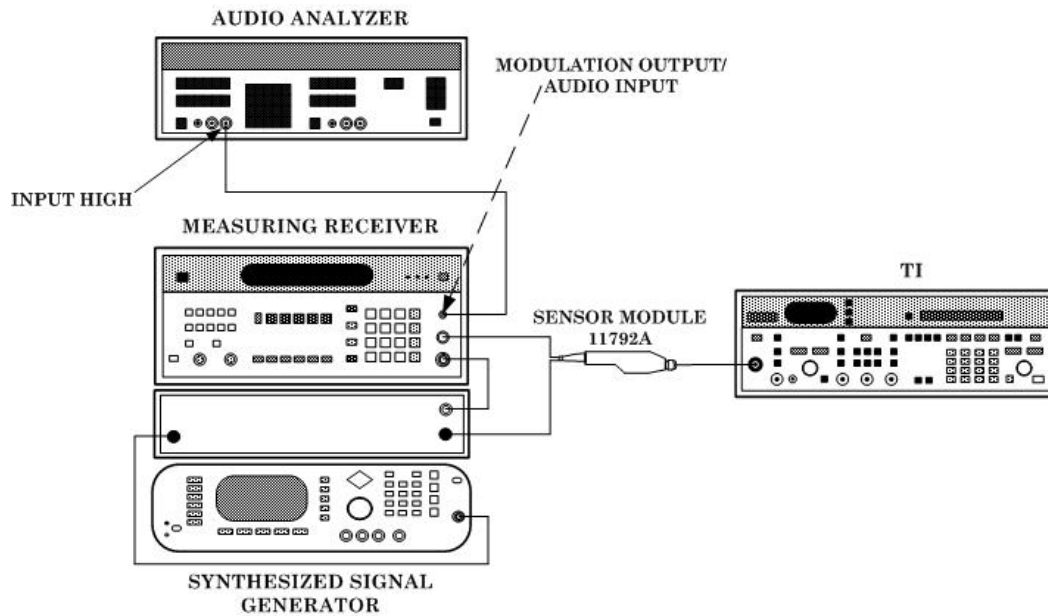

Figure 2. Frequency resolution hookup.

(4) Press TI keys as listed in (a) through (f) below.

- (a) **RCL 0.**
- (b) Adjust **OUTPUT LEVEL** for **0 dB.**
- (c) **ALC INTERNAL** on.
- (d) **RF OUTPUT** on.
- (e) **FREQ INCR, 1, kHz.**
- (f) **FREQUENCY, 4, GHz.**

(5) Set local oscillator and measuring receiver to measure 4 GHz, using the local oscillator, and measuring receiver offset frequencies listed in table 3.

(6) Record the measuring receiver frequency indication as reference.

(7) Calculate the minimum and maximum limits for the 4 GHz rows in table 3 using the formula below:

$$\text{Minimum} = (\text{Reference} + \text{TI increment amount}) - \text{FREQ INCR setting}$$

$$\text{Maximum} = (\text{Reference} + \text{TI increment amount}) + \text{FREQ INCR setting}$$

(8) Press the TI **FREQ INCREMENT** up arrow key three times as indicated in table 3, and verify that the indication is within the tolerances calculated in (7) above.

(9) Press the TI **FREQ INCREMENT** down arrow key four times as indicated in table, and verify that the indication is within the tolerances calculated in (7) above.

(10) Repeat (4)(e) through (9) above for settings of **FREQUENCY** 8 GHz with **FREQ INCR** of 2 kHz, and **FREQUENCY** 15 GHz with **FREQ INCR** of 3 kHz.

Table 3. Frequency Increment

Local oscillator (GHz)	Measuring receiver offset (MHz)	Test instrument			Tolerance	
		Frequency (GHz)	Step increment direction	Increment amount	Min	Max
4.12053	4120.530	4.000000	UPUPUP	.003		
4.12053	4120.530	4.000000	DNDNDNDN	-.001		
8.12053	8120.530	8.000000	UPUPUP	.006		
8.12053	8120.530	8.000000	DNDNDNDN	-.002		
15.12053	15120.530	15	UPUPUP	.009		
15.12053	15120.530	15	DNDNDNDN	-.003		

(11) Press TI keys as listed in (a) through (f) below.

- (a) **RCL 0.**
- (b) Adjust **OUTPUT LEVEL** for 0 dB.
- (c) **ALC INTERNAL** on.

TB 9-6625-2155-35

- (d) **RF OUTPUT** on.
- (e) **FREQ INCR, 1, 1, 1, ., 1, 1, 3,** and **MHz.**
- (f) **FREQUENCY, 2, GHz.**

(12) Set local oscillator and measuring receiver to measure 2 GHz, using the local oscillator, and measuring receiver offset frequencies listed in table 4.

(13) Verify that the measuring receiver indicates within tolerances listed in table 4.

(14) Repeat (11)(e) through (13) above for remaining settings in table 4 verifying measuring receiver indicates within the tolerances listed.

Table 4. Frequency Resolution

Local oscillator (GHz)	Measuring receiver offset (MHz)	Test instrument			Signal generator workstation indications	
		Frequency (GHz)	Step increment setting	Step increment direction	Minimum	Maximum
2.120530	2120.530	2	111.113		1999.99700M	2000.00300M
2.231643	2231.643			UP	2111.11000M	2111.11600M
2.342756	2342.756			UP	2222.22300M	2222.22900M
2.453869	2453.869			UP	2333.33600M	2333.34200M
2.564982	2564.982			UP	2444.44900M	2444.45500M
2.676095	2676.095			UP	2555.56300M	2555.56800M
2.787208	2787.208			UP	2666.67600M	2666.68100M
2.898321	2898.321			UP	2777.78800M	2777.94000M
3.009434	3009.434			UP	2888.90100M	2888.90700M
3.120530	3120.530	2	1000	UP	2999.99700M	3000.00300M
4.120530	4120.530			UP	3999.99700M	4000.00300M
5.120530	5120.530			UP	4999.99700M	5000.00300M
6.120530	6120.530			UP	5999.99700M	6000.00300M
7.120530	7120.530			UP	6999.99700M	7000.00300M
8.120530	8120.530			UP	7999.99700M	8000.00300M
9.120530	9120.530			UP	8999.99700M	9000.00300M
10.12053	10120.53			UP	9999.99700M	10000.00300M
11.12053	11120.53			UP	10999.99700M	11000.00300M
12.12053	12120.53			UP	11999.99700M	12000.00300M
13.12053	13120.53			UP	12999.99700M	13000.00300M
14.12053	14120.53			UP	13999.99700M	14000.00300M
15.12053	15120.53			UP	14999.99700M	15000.00300M
16.12053	16120.53			UP	15999.99700M	16000.00300M
17.12053	17120.53			UP	16999.99700M	17000.00300M
18.12053	18120.53			UP	17999.99700M	18000.00300M

(15) Disconnect TI **10 MHz OUT** (rear panel) from the local oscillator **10 MHz REF IN** connector.

(18) DELETED

b. Adjustments. No adjustments can be made.

9. Single Sideband Phase Noise

a. Performance Check

(1) Connect equipment as shown in figure 3.

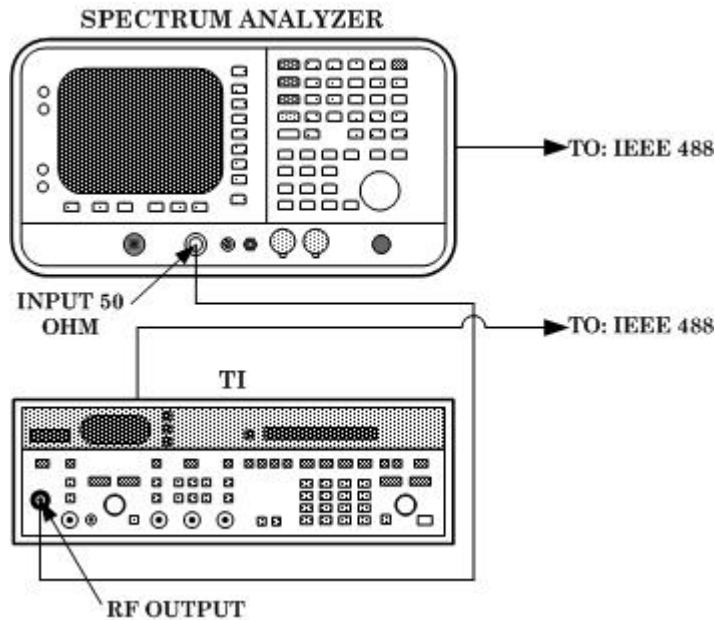

Figure 3. Sideband phase noise hookup.

(2) Press TI keys as listed in (a) through (e) below.

- (a) **RCL 0.**
- (b) Adjust **OUTPUT LEVEL** for **8 dB.**
- (c) **ALC INTERNAL** on.
- (d) **RF OUTPUT** on.
- (e) **FREQUENCY, 5, ., 9, 9, 9, GHz.**

(3) Set spectrum analyzer as listed in (a) through (f).

- (a) **Preset.**
- (b) **AMPLITUDE, Ref Level** to **8 dBm.**
- (c) All markers off.
- (d) **FREQUENCY, Center Freq** to **5.999 GHz.**
- (e) **BW, Video BW, and Res BW** to **Auto.**
- (f) **SPAN** to **1 MHz.**

(4) Allow spectrum analyzer to sweep signal a couple of times then set spectrum analyzer as listed in (a) through (c) below:

TB 9-6625-2155-35

- (a) **FREQUENCY, Signal Track to On.**
- (b) **SPAN to 2.5 kHz.**
- (c) **BW/Avg, Video BW to 10 Hz.**

(5) Allow spectrum analyzer to sweep signal for approximately 50 seconds then set spectrum analyzer as listed in (a) through (d) below.

- (a) **Marker, Off.**
- (b) **View/Trace, Trace 1, View.**
- (c) **Marker, Delta, to 1 kHz.**
- (d) **Marker, More, Function, Marker Noise.**

(6) Spectrum analyzer **Mkr Δ** will indicate less than or equal to the minimum indication listed in table 5.

(7) Repeat technique of (2) through (6) above for remaining frequencies listed in table 5.

Table 5. Side Band Phase Noise 1 kHz Removed

Test instrument frequency (GHz)	Spectrum analyzer indication (dB) minimum (\leq)
5.999	-62.5
12	-62.5
18	-62.5

b. Adjustments. No adjustments can be made.

10. Harmonics, Subharmonics, Multiples and Non-harmonic Spurious Signals

a. Performance Check

(1) Connect equipment as shown in figure 4 below.

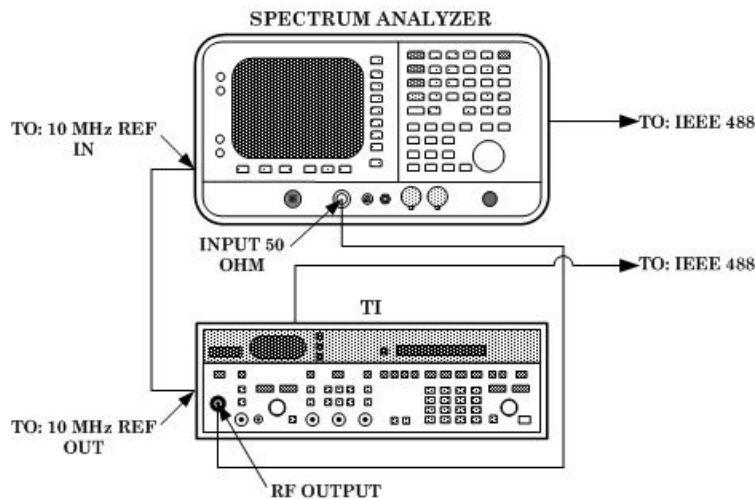

Figure 4. Harmonic, subharmonic, multiples and non-harmonic spurious hookup.

- (2) Press TI keys as listed in (a) through (e) below.
 - (a) **RCL 0.**
 - (b) Adjust **OUTPUT LEVEL** for **-3 dB.**
 - (c) **ALC INTERNAL** on.
 - (d) **RF OUTPUT** on.
 - (e) **FREQUENCY, 2, GHz.**
- (3) Set spectrum analyzer controls as listed in (a) through (g).
 - (a) **Preset.**
 - (b) **AMPLITUDE, Ref Level** to **3 -dBm.**
 - (c) **Video BW** to **Auto.**
 - (d) **Res BW** to **10 kHz.**
 - (e) **SPAN** to **1 MHz.**
 - (f) All markers off.
 - (g) **FREQUENCY, Center Freq** to **2 GHz.**
- (4) Allow the display to sweep a few times then set spectrum analyzer as listed in (a) through (d).
 - (a) **Peak Search.**
 - (b) **Marker →, Marker→ CF.**
 - (c) **Marker Delta.**
 - (d) **FREQUENCY, Center Freq,** (harmonic frequency listed in table 6) **GHz.**
- (5) The spectrum analyzer **MkrΔ** will indicate less than or equal to the minimum limit listed in table 6.
- (6) Set TI frequency to next frequency listed in table 6 and repeat (3)(f) through (5) above.
- (7) Repeat (6) above for remaining frequencies listed in table 6.

Table 6. Harmonic Distortion Check

Test instrument frequency (GHz)	Harmonic frequency	Harmonic	Spectrum analyzer indication (dB) maximum (≤)
2	4	2nd	-40
4	8	2nd	-40
6	12	2nd	-40
8	16	2nd	-40
8	4	.5	-35
10	5	.5	-35
12	6	.5	-35

Table 6. Harmonic Distortion Check - Continued

Test instrument frequency (GHz)	Harmonic frequency	Harmonic	Spectrum analyzer indication (dB) maximum (\leq)
14	4.6667	.33	-35
14	9.3333	.66	-35
16	5.3333	.33	-35
16	10.6667	.66	-35
18	6	6 GHz Sub	-35
18	12	12 GHz Sub	-35

(8) Press TI **FREQUENCY**, **2.5**, and **GHZ** keys.

(9) Set spectrum analyzer center frequency to **2.5 GHz**, video bandwidth to **Auto**, resolution bandwidth to **10 kHz**, and span to **1 MHz**.

(10) Using the spectrum analyzer, verify that all non-harmonic spurious signals are ≤ 50 dBc TI frequencies listed in table 7.

Table 7. Non-harmonic Spurious Signal Level

Test instrument frequency (GHz)	Spurious signal level
2.500 000	< -50 dBc
3.000 000	< -50 dBc
3.500 000	< -50 dBc
4.500 000	< -50 dBc
5.000 000	< -50 dBc
5.500 000	< -50 dBc
6.500 000	< -50 dBc

(11) Reduce all outputs to minimum and disconnect equipment.

b. Adjustments. No adjustments can be made.

11. RF Output Level

a. Performance Check

(1) Connect equipment as shown in figure 5.

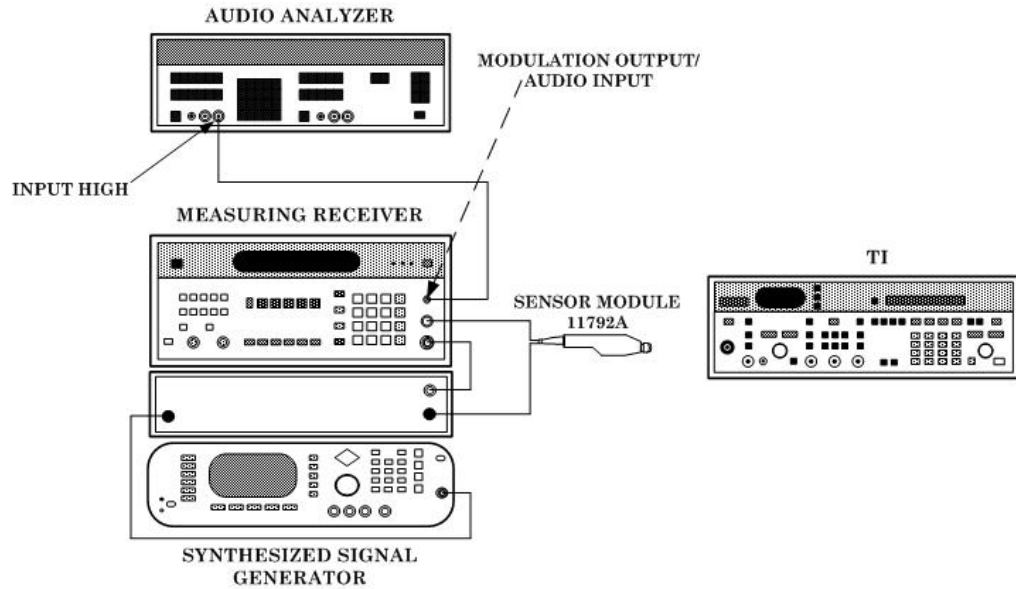

Figure 5. RF output hookup.

(2) Connect sensor module to measuring receiver **CALIBRATION RF POWER OUTPUT**.

(3) Connect TI **RF OUTPUT** to measuring receiver power sensor.

(4) Press TI keys as listed in (a) through (e) below.

- (a) **RCL 0**.
- (b) Adjust **OUTPUT LEVEL** for **-3 dB**.
- (c) **ALC INTERNAL** on.
- (d) **RF OUTPUT** on.
- (e) **FREQUENCY, 2, GHz**.

(5) Using measuring receiver and tuned level techniques in **LOG** mode, sweep the TI from 2 GHz to 18 GHz in 1 GHz steps, and record the highest and lowest levels.

(6) Calculate the flatness using the formula below. The flatness will be less than or equal to the maximum limit listed in table 8.

$$\text{Flatness} = (\text{highest} - \text{lowest}) / 2$$

Table 8. Output Level Flatness

Start frequency	Stop frequency	Max limit
2 GHz	18 GHz	1.999

(7) Press TI **FREQUENCY, 2, and GHz** keys. Verify the measuring receiver indicates within minimum and maximum limits for TI output levels listed in table 9 below, using standard tuned level measurement techniques.

Table 9. 2 GHz Output Level Test

Test instrument output level	Min	Max
0	-2	2
-10	-12	-8
-20	-22	-18
-30	-32	-28
-40	-42	-38
-50	-52	-48
-60	-62	-58
-70	-73.5	-66.5
-80	-83.5	-76.5
-90	-93.5	-86.5
-100	-103.5	-96.5

(8) Press TI **FREQUENCY**, **6**, and **GHz** keys. Verify the measuring receiver indicates within minimum and maximum limits for TI output levels listed in table 10 below, using standard tuned level measurement techniques.

Table 10. 6 GHz Output Level Test

Test instrument output level	Min	Max
0	-2	2
-10	-12	-8
-20	-22	-18
-30	-32	-28
-40	-42	-38
-50	-52	-48
-60	-62	-58
-70	-73.5	-66.5
-80	-83.5	-76.5
-90	-93.5	-86.5
-100	-103.5	-96.5

(9) Press TI **FREQUENCY**, **12**, and **GHz** keys. Verify the measuring receiver indicates within minimum and maximum limits for TI output levels listed in table 11 below, using standard tuned level measurement techniques.

Table 11. 12 GHz Output Level Test

Test instrument output level	Min	Max
0	-2	2
-10	-12	-8
-20	-22	-18
-30	-32	-28
-40	-42	-38

Table 11. 12 GHz Output Level Test - Continued

Test instrument output level	Min	Max
-50	-52	-48
-60	-62	-58
-70	-73.5	-66.5
-80	-83.5	-76.5
-90	-93.5	-86.5
-100	-103.5	-96.5

(10) Press TI **FREQUENCY**, **12.5**, and **GHz** keys. Verify the measuring receiver indicates within minimum and maximum limits for TI output levels listed in table 12 below, using standard tuned level measurement techniques.

Table 12. 12.5 GHz Output Level Test

Test instrument output level	Min	Max
0	-3	3
-10	-13	-7
-20	-23	-17
-30	-33	-27
-40	-43	-37
-50	-53	-47
-60	-63	-57
-70	-74.5	-65.5
-80	-84.5	-75.5
-90	-94.5	-85.5

(11) Press TI **FREQUENCY**, **18**, and **GHz** keys. Verify the measuring receiver indicates within minimum and maximum limits for TI output levels listed in table 13 below, using standard tuned level measurement techniques.

Table 13. 18 GHz Output Level Test

Test instrument output level	Min	Max
0	-3	3
-10	-13	-7
-20	-23	-17
-30	-33	-27
-40	-43	-37
-50	-53	-47
-60	-63	-57
-70	-74.5	-65.5
-80	-84.5	-75.5
-90	-94.5	-85.5

b. Adjustments

- (1) Remove TI protective covers.
- (2) Press TI **FREQUENCY, 2 ,GHz** keys and adjust the output level to -3 dB.
- (3) Set the measuring receiver to measure tuned power at 2 GHz in a **LOG** mode.
- (4) Press number **6** pushbutton on the TI.
- (5) Press service switch A2A2S1 (fig. 6).

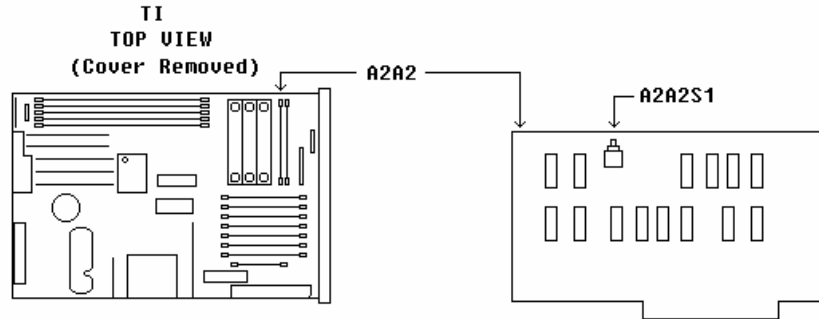

Figure 6. A2A2 board.

- (6) Press TI RCL 1.
- (7) Adjust A1A2A2R29 (fig. 7) for a measuring receiver indication of -3.0 dBm (R).

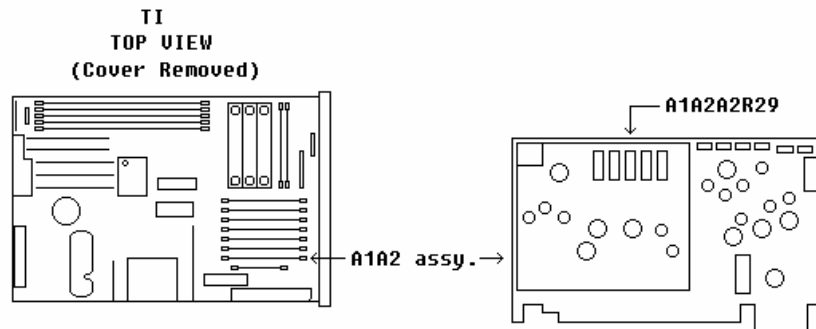

Figure 7. A1A2 board.

- (8) Using **TUNE KNOB**, tune the test instrument from 2 to 6.6 GHz. Record minimum and maximum measuring receiver indications and frequencies where they occur.
- (9) Adjust A1A8R55 (fig. 8) to reduce the difference between minimum/maximum power indications (R).

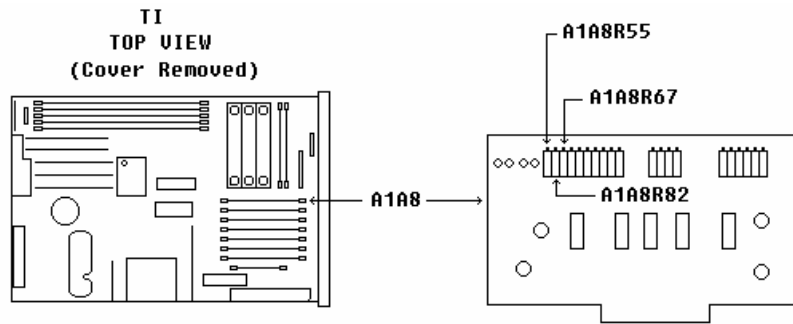

Figure 8. A1A8 board.

- (10) Using **TUNE KNOB**, tune the test instrument to 2 GHz.
- (11) Readjust A1A2A2R29 (fig. 7) for a measuring receiver indication of 3.0 dBm.
- (12) Tune the test instrument from 2 to 6.6 GHz. Verify that the output level stays within ± 1 dB of -3 dBm.
- (13) Repeat (8) through (12) above until level stays within 1 dB of -3 dBm or until no further improvement can be made.
- (14) Press TI **RCL 2**.
- (15) Using **TUNE KNOB**, tune the test instrument from 6.600002 to 12.99902 GHz. Record minimum and maximum measuring receiver indications and frequencies where they occur.
- (16) Adjust A1A8R82 (fig 8) to minimize difference between minimum and maximum power indications (R).

NOTE

If minimum and maximum output power levels are more than ± 1.5 dB from -3 dBm, repeat the entire adjustment procedure until measuring receiver indicates within ± 1.5 dB of -3 dBm.

- (17) Press TI **SWEEP MODE OFF, FREQ INCR, 2, 0, 0**, and **MHz** keys.
- (18) Verify the measuring receiver indicates -3 dBm ± 0.2 dBm. Readjust A1A2A2R29 (fig. 7) as necessary for best compromise.
- (19) Using **TUNE KNOB**, tune the test instrument from 2 to 12.2 GHz. Verify that the difference between the minimum and maximum power indications are equal to or less than 3 dB.
- (20) Press TI **RCL** and **3** keys.
- (21) Using **TUNE KNOB**, tune the test instrument from 12.300003 to 17.59999901 GHz. Record minimum and maximum measuring receiver indications and frequencies where they occur.

TB 9-6625-2155-35

(22) Adjust A1A8R67 (fig. 8) to minimize difference between minimum and maximum power indications (R).

(23) Press **TI SWEEP MODE OFF**, **FREQUENCY**, **2**, and **GHz** keys.

(24) Adjust A1A2A2R29 (fig. 7) for a measuring receiver indication of -3.0 dBm.

(25) Press service switch A2A2S1 (fig. 6).

(26) Reduce TI RF output level to minimum.

(27) Replace TI top cover.

12. Pulse Modulation

a. Performance Check

(1) Disconnect cable from local oscillator **RF OUTPUT** connector.

(2) Connect equipment as shown in figure 9.

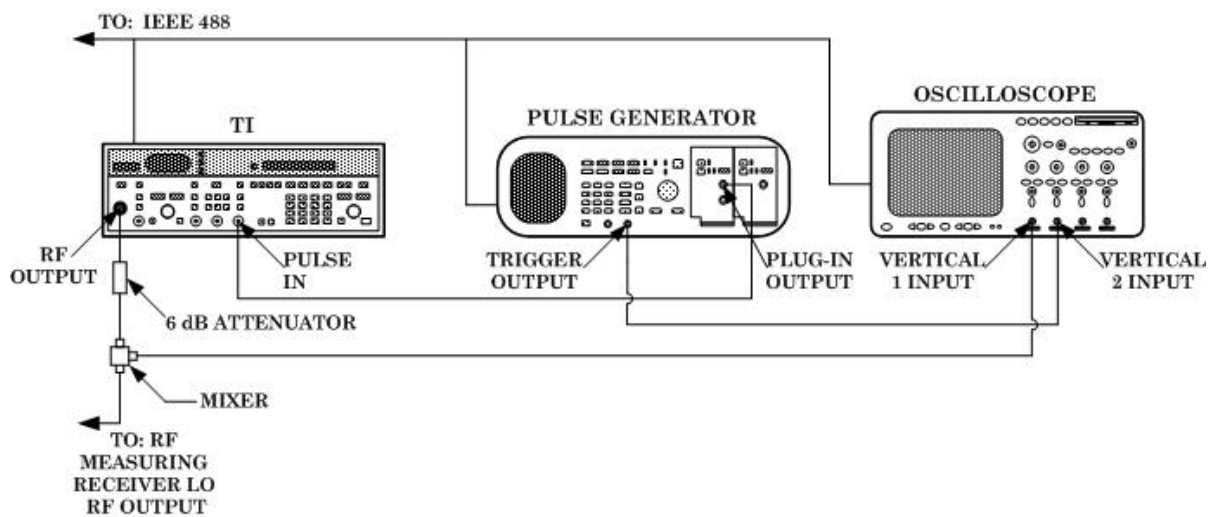



Figure 9. Pulse modulation hookup.

(3) Press TI keys as listed in (a) through (g) below.

(a) **RCL 0**.

(b) Adjust **OUTPUT LEVEL** for 3 dB.

(c) **ALC INTERNAL** on.

- (d) **RF OUTPUT** on.
 - (e) **FREQUENCY, 2, GHz.**
 - (f) **AUTO PEAK** on.
 - (g) **PULSE NORMAL** on.
- (4) Press local oscillator keys as listed in (a) through (e) below.
- (a) **RCL 0.**
 - (b) Adjust **OUTPUT LEVEL** for 8 dB.
 - (c) **ALC INTERNAL** on.
 - (d) **RF OUTPUT** on.
 - (e) **FREQUENCY, 2.05, GHz.**
- (5) Set the pulse generator to produced the outputs listed in (a) through (f) below.
- (a) **Recall Setup, Standard, Enter, Enter.**
 - (b) Frequency to 1 MHz.
 - (c) **A:Width to 110 nS.**
 - (d) **A:VHI to 5 V.**
 - (e) **A:VLO to 0 V.**
 - (f) **A:DISP** off.
- (6) Set the oscilloscope as listed in (a) through (i) below.
- (a) **Vertical, 1 and 2** on (lit).
 - (b) **Vertical, 1 and 2 Input to 50Ω** (lit) .
 - (c) **Vertical 1**, scale to **20 mV.**
 - (d) **Vertical 2**, scale to **100 mV.**
 - (e) **Trigger Sweep** to **Auto.**
 - (f) **Trigger Source** to **2.**
 - (g) **Trigger Coupling** to **DC.**
 - (h) **Trigger Slope** to .
 - (i) **Horizontal** sweep speed to **200 ns.**

NOTE

The next several tests require that you adjust the oscilloscope as necessary to obtain a centered 5 division pulse as shown in figure 10.

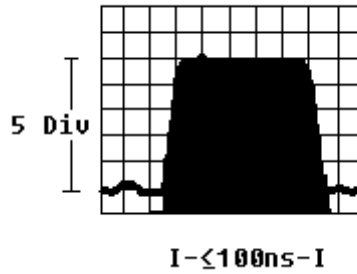

Figure 10. Pulse modulated display.

(7) Verify pulse overshoot and undershoot is less than 20% and ALC UNLEVEL light on TI is extinguished. If signal is not within limits specified perform adjustments listed in **b** below.

(8) Set TI, and local oscillator to the remaining frequencies and levels listed in table 14, and repeat (7) above at each frequency.

Table 14. Pulse Modulation Overshoot and Undershoot Check

Test instrument		LO Frequency (GHz)	Description
Frequency (GHz)	Level (dB)		
2.00	3	2.050	Overshoot Undershoot @ 2.0 GHz +3dBm
2.00	-10	2.050	Overshoot Undershoot @ 2.0 GHz - 10dBm
6.60	3	6.650	Overshoot Undershoot @ 6.6 GHz +3dBm
6.60	-10	6.650	Overshoot Undershoot @ 6.6 GHz - 10dBm
6.60	0	6.650	Overshoot Undershoot @ 6.6 GHz 0dBm
6.70	3	6.750	Overshoot Undershoot @ 6.7 GHz +3dBm
6.70	-10	6.750	Overshoot Undershoot @ 6.7 GHz - 10dBm
6.70	0	6.750	Overshoot Undershoot @ 6.7 GHz 0dBm
12.290	3	12.340	Overshoot Undershoot @ 12.29 GHz +3dBm
12.290	-10	12.340	Overshoot Undershoot @ 12.29 GHz - 10dBm
12.290	0	12.340	Overshoot Undershoot @ 12.29 GHz 0dBm
12.300	3	12.350	Overshoot Undershoot @ 12.3 GHz +3dBm
12.300	-10	12.350	Overshoot Undershoot @ 12.3 GHz - 10dBm

Table 14. Pulse Modulation Overshoot and Undershoot Check - Continued

Test instrument		LO Frequency (GHz)	Description
Frequency (GHz)	Level (dB)		
12.300	0	12.350	Overshoot Undershoot @ 12.3 GHz 0dBm
18.000	3	18.050	Overshoot Undershoot @ 18.0 GHz +3dBm
18.000	-10	18.050	Overshoot Undershoot @ 18.0 GHz - 10dBm
18.000	0	18.050	Overshoot Undershoot @ 18.0 GHz 0dBm
18.000 ¹	8	18.050	Overshoot Undershoot @ 18.0 GHz 8dBm

¹Remove 6 dB attenuator pad before adjusting output level to 8 dB.

(9) Disconnect equipment setup, and reconnect local oscillator **RF OUTPUT** connector.

b. Adjustments

- (1) Remove TI top cover.
- (2) Press TI keys as listed in (a) through (g) below.
 - (a) **RCL, 0.**
 - (b) **FREQUENCY, 2, and GHz.**
 - (c) **OUTPUT LEVEL** to 3 dB.
 - (d) **RF OUTPUT** to on.
 - (e) **ALC INTERNAL** to on.
 - (f) **AUTO PEAK** to on.
 - (g) **PULSE** and **NORMAL** .

(3) Set the local oscillator to produce a 2.050 GHz signal at 8 dBm and turn the **RF OUTPUT** then **AUTO PEAK** on.

(4) Reset the pulse generator then set to produce a 1 MHz pulse train with a width of 100 ns, **VHI** of 5 and **VLO** of 0, and turn the output on.

- (5) Press oscilloscope controls as listed in (a) through (h) below:
 - (a) **Vertical 1 Input** to **50 Ω** (lit).
 - (b) **Vertical 1**, scale to **20 mV**.
 - (c) **Vertical 2 Input** to **50 Ω** (lit).
 - (d) **TRIGGER Sweep** to **Auto**.
 - (e) **TRIGGER Source** to **2**.

TB 9-6625-2155-35

- (f) **TRIGGER Coupling** to **DC**.
- (g) **TRIGGER Slope** to .
- (h) **Horizontal** sweep speed to **200 nS**.
- (6) Adjust oscilloscope as required for centered five division pulse as in figure 10.
- (7) Adjust A1A4R25 (fig. 11) for best pulse shape (R).

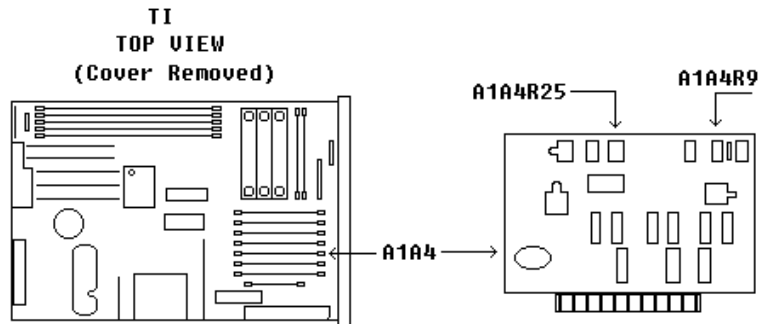

Figure 11. A1A4 adjustment locations.

- (8) Adjust A1A4R9 (fig. 11) cw until **ALC UNLEVEL** light is on, then adjust A1A4R9 ccw until **ALC UNLEVEL** light is extinguished (R).
- (9) Reduce all outputs to minimum.
- (10) Replace TI top cover.

13. Amplitude Modulation

a. Performance Check

- (1) Connect equipment as shown in figure 12 below.

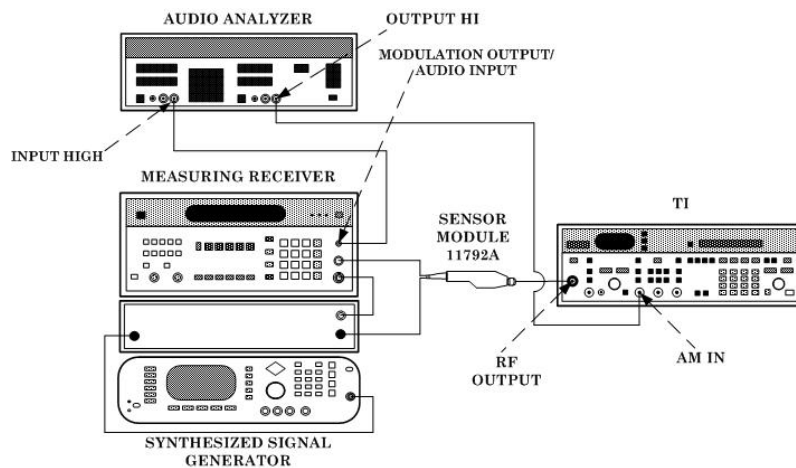

Figure 12. Amplitude modulation hookup.

(2) Press TI keys as listed in (a) through (e) below.

- (a) **RCL 0.**
- (b) Adjust **OUTPUT LEVEL** for -13 dB.
- (c) **ALC INTERNAL** on.
- (d) **RF OUTPUT** on.
- (e) **FREQUENCY, 16.6, GHz.**

(3) Set audio analyzer as listed in (a) through (d) below.

- (a) **PRGM 99 ENTER RCL.**
- (b) 600Ω output.
- (c) Source frequency 1 kHz.
- (d) Source level 0.7 V.

(4) Set measuring receiver to measure amplitude modulation, with +PEAK detector, high pass and Lo pass filters off and at a frequency of 16.6 GHz.

(5) Press TI **AM MTR** and **100%AM** keys. Adjust the audio analyzer output level of a 50.0 ±0.1% AM indication on the measuring receiver.

(6) If the TI meter does not indicate within limits listed in table 15 perform **b** below.

(7) Repeat (5) and (6) above for the 75% AM meter indication listed in table 15.

Table 15. AM Meter

Test description	Test instrument meter indication	
	Min	Max
50% AM meter	43.5	56.5
75% AM meter	70	80

(8) Press TI keys as listed in (a) through (b) below.

- (a) Adjust **OUTPUT LEVEL** for -0 dB.
- (b) **FREQUENCY, 3.9, GHz.**

(9) Set audio analyzer as listed in (a) through (b) below.

- (a) Source frequency 1 kHz.
- (b) Source level 0.425 V.

(10) Set measuring receiver to measure amplitude modulation, with +PEAK detector, high pass and Lo pass filters off and at a frequency of 3.9 GHz.

(11) Press TI **AM MTR** and **100%AM** keys. Adjust the audio analyzer output level of a 30.0 ±0.05% AM indication on the measuring receiver.

TB 9-6625-2155-35

(12) Set audio analyzer to measure **LEVEL** and set units to **dB** then select **RATIO** mode.

(13) Set the audio analyzer to the frequencies listed in table 16; the audio analyzer will indicate within limits listed in table 16.

Table 16. External AM Frequency Response

Test description	Audio analyzer frequency (Hz)	Audio analyzer indication	
		Min (dB)	Max (dB)
50 Hz response	50	-3	3
400 Hz response	400	-3	3
500 Hz response	500	-3	3
25 kHz response	25000	-3	3
50 kHz response	50000	-3	3

(14) Set audio analyzer as listed in (a) through (d) below.

- (a) **PRGM 99 ENTER RCL.**
- (b) 600Ω output.
- (c) Source frequency 1 kHz.
- (d) Source level 0.7 V.

(15) Set local oscillator and measuring receiver to measure a frequency of 3.9 GHz.

(16) Set audio analyzer to measure distortion.

(17) The audio analyzer will indicate within limits listed in table 17 for the current audio analyzer source frequency and level.

(18) Set the audio analyzer to produced a 10 kHz signal at 0.425 V.

(19) Set measuring receiver to measure FM using + **PEAK** detector.

(20) The measuring receiver will indicate within limits listed in table 17 for the current audio analyzer source frequency and level.

(21) Press measuring receiver **INST PRESET.**

(22) Set TI frequency to 6.2 GHz, and set measuring receiver and local oscillator to measure 6.2 GHz using the offset frequencies listed in table 17.

(23) Set measuring receiver to measure FM using + **PEAK** detector. The measuring receiver will indicate within limits listed in table 17 for the current frequency.

(24) Repeat (22) and (23) for remaining settings in table 17.

Table 17. Distortion, Incidentals, and Residuals

Test description	Audio analyzer		Test instrument frequency (GHz)	Offset frequency (MHz)	Audio analyzer /measuring receiver maximum
	Frequency	Level			
Pct. Dist @ 1kHz	1000	.7	3.9	-----	8
Inc. FM @ 3.9 GHz	10000	.425	3.9	4020.53	10000
Inc. FM @ 6.2 GHz	-----	-----	6.2	6320.530	10000
Inc FM @ 12.3 GHz	-----	-----	12.3	12420.530	10000
Inc. FM @ 18 GHz	-----	-----	18	18120.530	10000
Res FM @ 6.2 GHz	-----	-----	6.2	6320.530	10000
Res FM @ 12.3 GHz	-----	-----	12.3	12420.530	10000
Res FM @ 18 GHz	-----	-----	18	18120.530	10000

(25) Press **TI AM OFF** and repeat (22) and (23) for the remaining frequencies listed in table 17. Measuring receiver will indicate within the limits listed in table 17.

(26) Disconnect equipment setup.

b. Adjustments

(1) Remove TI top cover.

(2) Press TI keys as listed in (a) through (g) below:

- (a) **RCL 0.**
- (b) **ALC INTERNAL** to on.
- (c) **FREQUENCY 1, 6, ., 6, and GHz.**
- (d) Adjust **OUTPUT LEVEL** to **-10 dB.**
- (e) **RF OUTPUT** to on.
- (f) **MTR LVL** to on.
- (g) **AM 100%.**

(3) Set the audio analyzer to produce a 1 kHz, 1.06 V output with 600Ω output impedance, then select special function 17.

(4) Set measuring receiver and local oscillator to measure 16.6 GHz, then select **AM** measurement and **+ PEAK** detector.

(5) Adjust A1A3R83 (fig. 13) for an indication of 73.0% AM on the measuring receiver (R).

(6) Adjust A1A6R84 (fig. 13) until TI meter indicates 75% on middle scale of output meter (R).

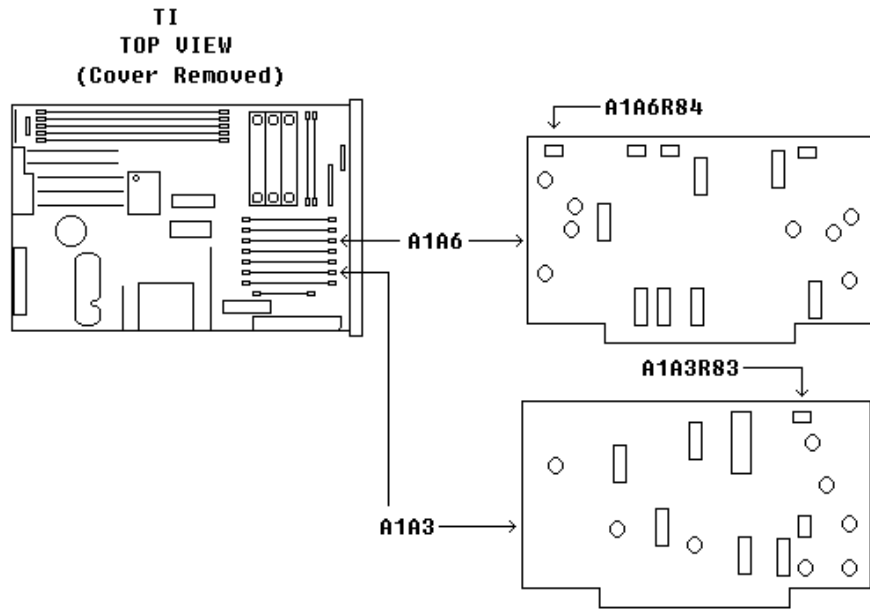

Figure 13. AM adjustment locations.

- (7) Reduce all outputs to minimum.
- (8) Replace TI top cover.

14. Frequency Modulation

a. Performance Check

- (1) Connect equipment as shown in figure 14 below.

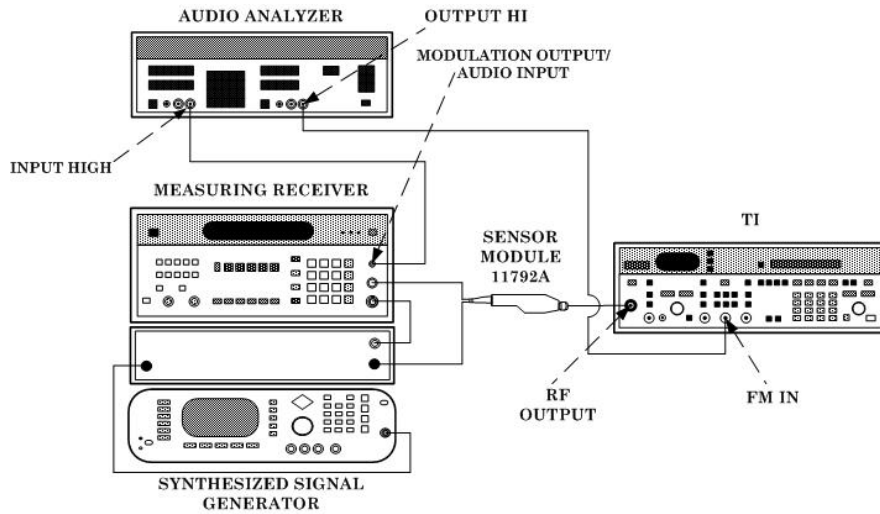

Figure 14. Frequency modulation hookup.

TB 9-6625-2155-35

(2) Press TI keys as listed in (a) through (g) below.

- (a) **RCL 0.**
- (b) Adjust **OUTPUT LEVEL** for 0 dB.
- (c) **ALC INTERNAL** on.
- (d) **RF OUTPUT** on.
- (e) **FREQUENCY, 15.0, GHz.**
- (f) **MTR FM.**
- (g) **FM DEVIATION .1 MHz.**

(3) Set audio analyzer as listed in (a) through (f) below.

- (a) **PRGM 99 ENTER RCL.**
- (b) **SPCL 17 ENTER.**
- (c) 50Ω output.
- (d) Source frequency 100 kHz.
- (e) Source level 1.4 V.
- (f) **LEVEL STEP 0.01V.**

(4) Set measuring receiver to measure frequency modulation, with + **PEAK** detector, high pass filter to 300 Hz and Lo pass filter off and at a frequency of 15 GHz.

(5) Adjust the audio analyzer output level for a 100.0 kHz indication on the TI meter.

(6) If the measuring receiver does not indicate within limits listed in table 18 perform **b** below.

Table 18. FM Meter Accuracy

Test description	Measuring receiver indication (Hz)	
	Min	Max
100 kHz FM meter	85 k	115 k

(7) Press TI keys as listed in (a) and (b) below.

- (a) **FREQUENCY, 4.0, GHz.**
- (b) **FM DEVIATION MHz OFF.**

(8) Set audio analyzer as listed in (a) and (b) below.

- (a) Source level 20 mV.
- (b) **LEVEL STEP 0.1mV.**

(9) Press TI **FM DEVIATION 10** button. Set measuring receiver to measure frequency modulation with +**PEAK** detector, high and Lo pass filter off, and at a frequency of 4 GHz.

(10) Using the up and down arrow keys, adjust the audio analyzer output level for a 140.0 ± 0.5 kHz FM deviation indication on the measuring receiver.

(11) Set audio analyzer to measure level and set units to dB, then set audio analyzer to ratio mode.

(12) Set audio analyzer to frequencies listed in table 19 and verify that audio analyzer level indication is within limits listed in table 19.

Table 19. External FM Frequency Response

Test description	Audio analyzer frequency (Hz)	Audio analyzer indication	
		Min	Max
50 Hz Response	50	-3	3
120 Hz Response	120	-3	3
500 Hz Response	500	-3	3
1 kHz Response	1000	-3	3
5 kHz Response	5000	-3	3
10 kHz Response	10000	-3	3
50 kHz Response	50000	-3	3

(13) Set audio analyzer as listed in (a) and (e) below.

- (a) Source level **20 mV**.
- (b) **LEVEL STEP 0.1mV**.
- (c) Frequency to **1 kHz**.
- (d) Analyzer distortion units to %.
- (e) Ratio mode off.

(14) Set measuring receiver high and Lo pass filters off and then select **FM** measurement with **+ PEAK** detector.

(15) Set audio analyzer frequency to 100 kHz and set ratio mode on.

(16) Set the audio analyzer to frequency listed in table 20 and verify that the audio analyzer level indicates less than the maximum listed in table 20.

(17) Press TI **FM DEVIATION OFF** and set frequency to 2 GHz.

(18) Adjust measuring receiver and local oscillator so that the measuring receiver will measure 2 GHz.

(19) Press TI **FM DEVIATION 1 MHz**.

(20) Set audio analyzer to produce a 0.707 V signal output.

(21) Set measuring receiver to measure **AM** with **+PEAK** detector.

(22) Measuring receiver will indicate less than the maximum limit listed in table 20.

(23) Set TI frequency to next setting listed in table 20 and repeat (18), (21), and (22).

(24) Repeat (23) above for remaining TI frequencies listed in table 20.

Table 20. Distortion and Incidentals

Test description	Audio analyzer		Test instrument frequency (GHz)	Offset frequency (MHz)	Measuring receiver/audio analyzer indication maximum
	Frequency	Level			
Pct. Dist. @ 100 kHz	100000	.020			5
Inc. AM @ 2 GHz			2	2120.530	5
Inc. AM @ 6.7 GHz			6.7	6820.530	5
Inc. AM @ 12.4 GHz			12.4	12520.532	5
Inc. AM @ 18 GHz			18	18120.531	5

(25) Disconnect all equipment.

b. Adjustments

(1) Remove TI top cover.

(2) Press TI keys as listed in (a) through (g) below:

- (a) **RCL 0.**
- (b) **ALC INTERNAL** to on.
- (c) **FREQUENCY 1, 5, and GHz.**
- (d) Adjust **OUTPUT LEVEL** to 0 dB.
- (e) **RF OUTPUT** to on.
- (f) **MTR FM** to on.
- (g) **FM DEVIATION MHz .1** on.

(3) Set the audio analyzer to produce a 100 kHz, 0.01 V LEVEL STEP size, 1.414 V output with 600Ω output impedance, then select special function 17.

(4) Set measuring receiver and local oscillator to measure 15 GHz, then select **FM** measurement and **300 Hz HP FILTER, 3 kHz LP FILTER,** and **+PEAK** detector.

(5) Adjust A1A6R35 (fig. 15) for an indication of 100.0 ±1 kHz FM deviation on the measuring receiver (R).

(6) Adjust A1A6R70 (fig. 15) until TI meter indicates 100 kHz FM deviation (needle at full scale) (R).

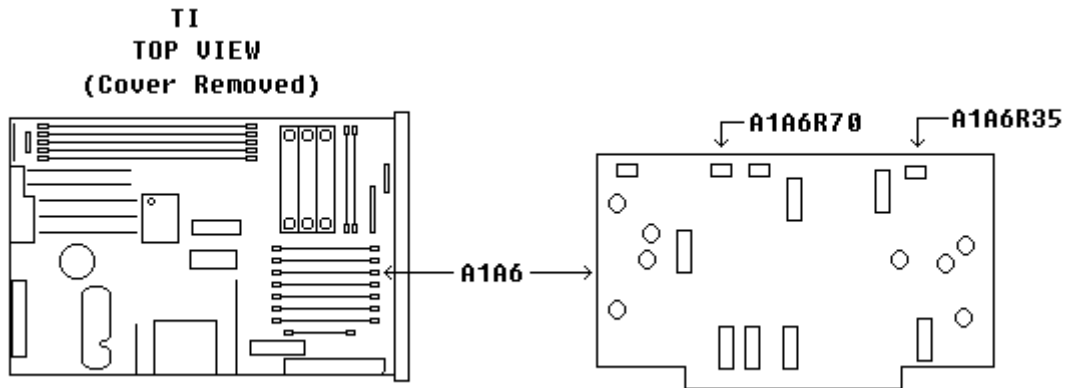

Figure 15. FM Adjustment locations.

- (7) Reduce all outputs to minimum.
- (8) Replace TI top cover.

15. Power Supply

a. Performance Check

(1) Connect digital voltmeter to A3A1TP1 and chassis (fig. 16). If digital voltmeter does not indicate between +21.98 and +22.02 V dc, perform **b** (1) below.

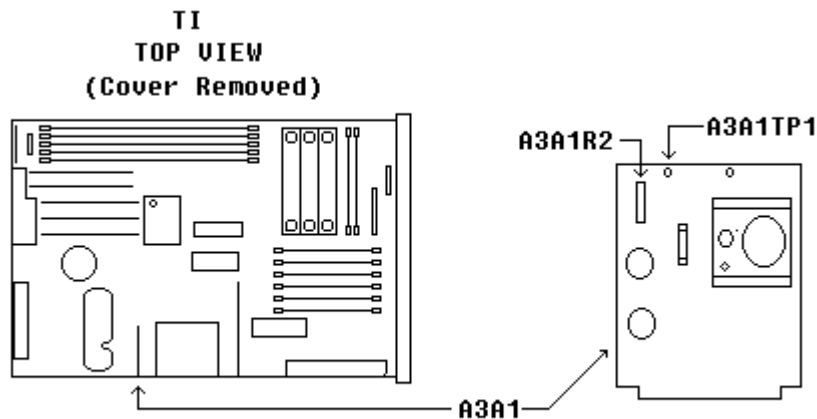

Figure 16. A3A1 card.

(2) Connect digital voltmeter to A3A3TP5 (fig. 17) and chassis. If digital voltmeter does not indicate between +19.998 V dc and +20.002 V dc, perform **b** (2) below.

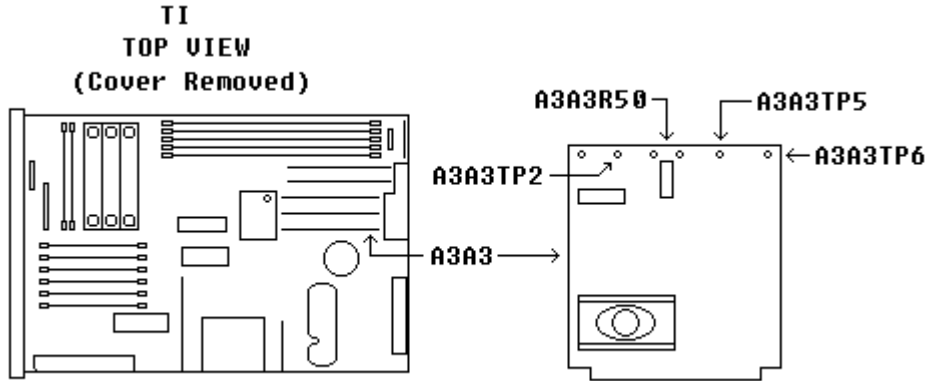

Figure 17. A3A3 card.

(3) Repeat technique of (2) above for test points and indications in table 13.

Table 13. Power Supply Checks

Test instrument test points	Voltage (V dc)	
	Min	Max
A3A3TP6 (fig. 11)	+9.9	+12.1
A3A3TP2 (fig. 11)	+5.1	+5.3
A3A4TP5 (fig. 12)	-5.15	-5.25
A3A4TP4 (fig. 12)	-9.8	-10.2
A3A4TP1 (fig. 12)	-39.0	-40.6

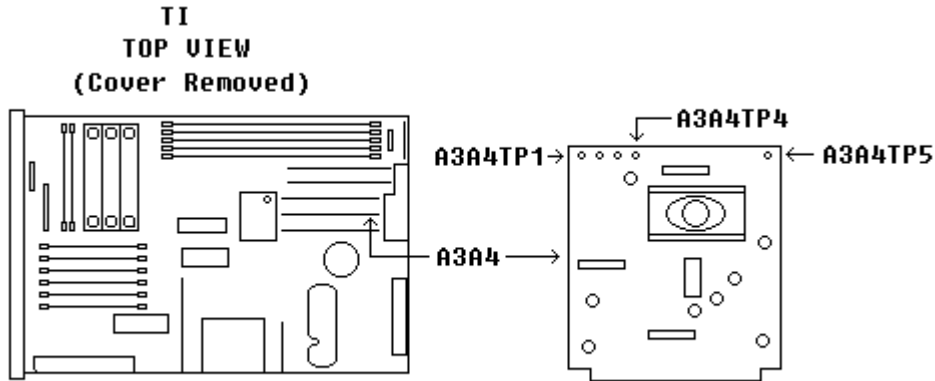

Figure 18. A3A4 Card.

b. Adjustments

- (1) Adjust A3A1R2 (fig. 16) for an indication of +22.00 V dc on digital voltmeter (R).
- (2) Adjust A3A3R50 (fig. 17) for an indication of 20.000 V dc on digital voltmeter. No further adjustments can be made (R).

TB 9-6625-2155-35

16. Final Procedure

- a. Deenergize and disconnect all equipment.
- b. Annotate and affix DA label/form in accordance with TB 750-25.

By Order of the Secretary of the Army:

Official



JOEL B. HUDSON

*Administrative Assistant to the
Secretary of the Army*

0318208

PETER J. SCHOOMAKER
*General, United States Army
Acting Chief of Staff*

Distribution:

To be distributed in accordance with IDN 342253, requirements for calibration procedure
TB 9-6625-2155-35.

Instructions for Submitting an Electronic 2028

The following format must be used if submitting an electronic 2028. The subject line must be exactly the same and all fields must be included; however, only the following fields are mandatory: 1, 3, 4, 5, 6, 7, 8, 9, 10, 13, 15, 16, 17, and 27.

From: "Whomever" whomever@redstone.army.mil
To: <2028@redstone.army.mil

Subject: DA Form 2028

1. **From:** Joe Smith
2. **Unit:** home
3. **Address:** 4300 Park
4. **City:** Hometown
5. **St:** MO
6. **Zip:** 77777
7. **Date Sent:** 19-OCT -93
8. **Pub no:** 55-2840-229-23
9. **Pub Title:** TM
10. **Publication Date:** 04-JUL-85
11. **Change Number:** 7
12. **Submitter Rank:** MSG
13. **Submitter FName:** Joe
14. **Submitter MName:** T
15. **Submitter LName:** Smith
16. **Submitter Phone:** 123-123-1234
17. **Problem:** 1
18. **Page:** 2
19. **Paragraph:** 3
20. **Line:** 4
21. **NSN:** 5
22. **Reference:** 6
23. **Figure:** 7
24. **Table:** 8
25. **Item:** 9
26. **Total:** 123
27. **Text**

This is the text for the problem below line 27.

PIN: 064151-000